

Sensitive measurement of water content in dry material using low-frequency terahertz time-domain spectroscopy system equipped with micro-structured photoconductive antennas

Takeshi Yasui^{1,2} and Tsutomu Araki²

¹Inst. Tech. Sci., Univ. Tokushima, Japan

²Grad. Sch. Engg. Sci., Osaka Univ., Japan

**1st EOS Topical Meeting on Micro- and Nano-Optoelectronic
Systems @ Bremen**

What is THz electromagnetic pulse ?

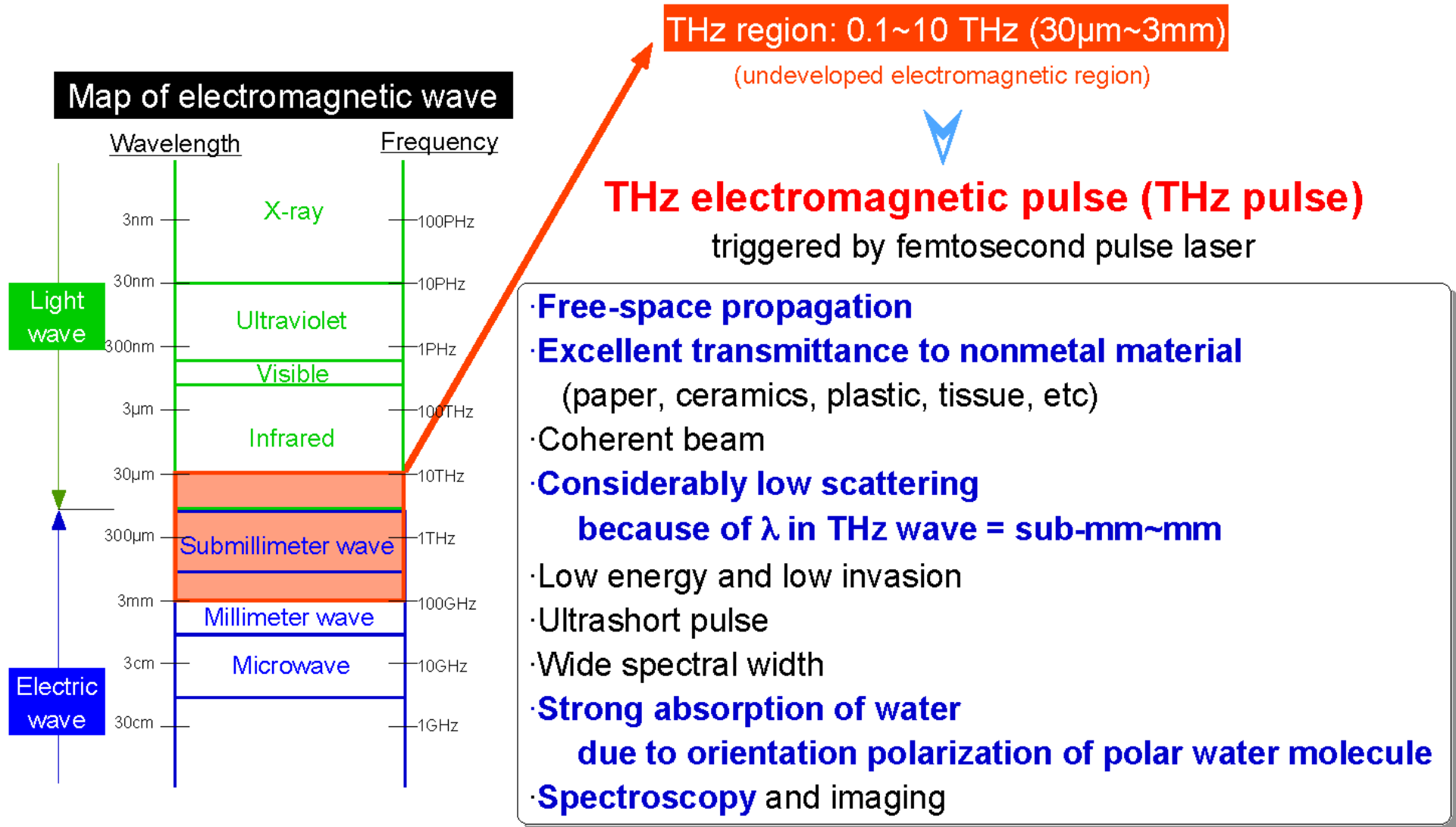

Blue characteristics are advantageous to water content measurement in dried material !

Introduction

Sensitive measurement of water content is required for quality control of dry materials (dried foods, industrial products, etc)!

Conventional methods

(1) Weight measurement with electronic balance

Non-contact, remote monitoring of water content is difficult!

(2) IR spectroscopy

Strong IR absorption due to vibrational polarization of water molecule!

Limited to transparent materials because of scattering in turbid material!

(3) THz time-domain spectroscopy (THz-TDS) *New!*

Strong THz absorption due to orientation polarization of polar water molecule!

Considerably low scattering are effective for turbid material!

Too strong THz absorption of water ($= 230\text{cm}^{-1}$ at 1THz) at high-frequency THz region ($>1\text{THz}$) often demands on limitations on samples, such as considerably thin or dry.

*To improve limitations on samples
using moderate absorption of water at low-frequency THz region*

Present
talk

**Sensitive measurement of water content in dry materials
based on low-frequency THz-TDS**

Experimental setup

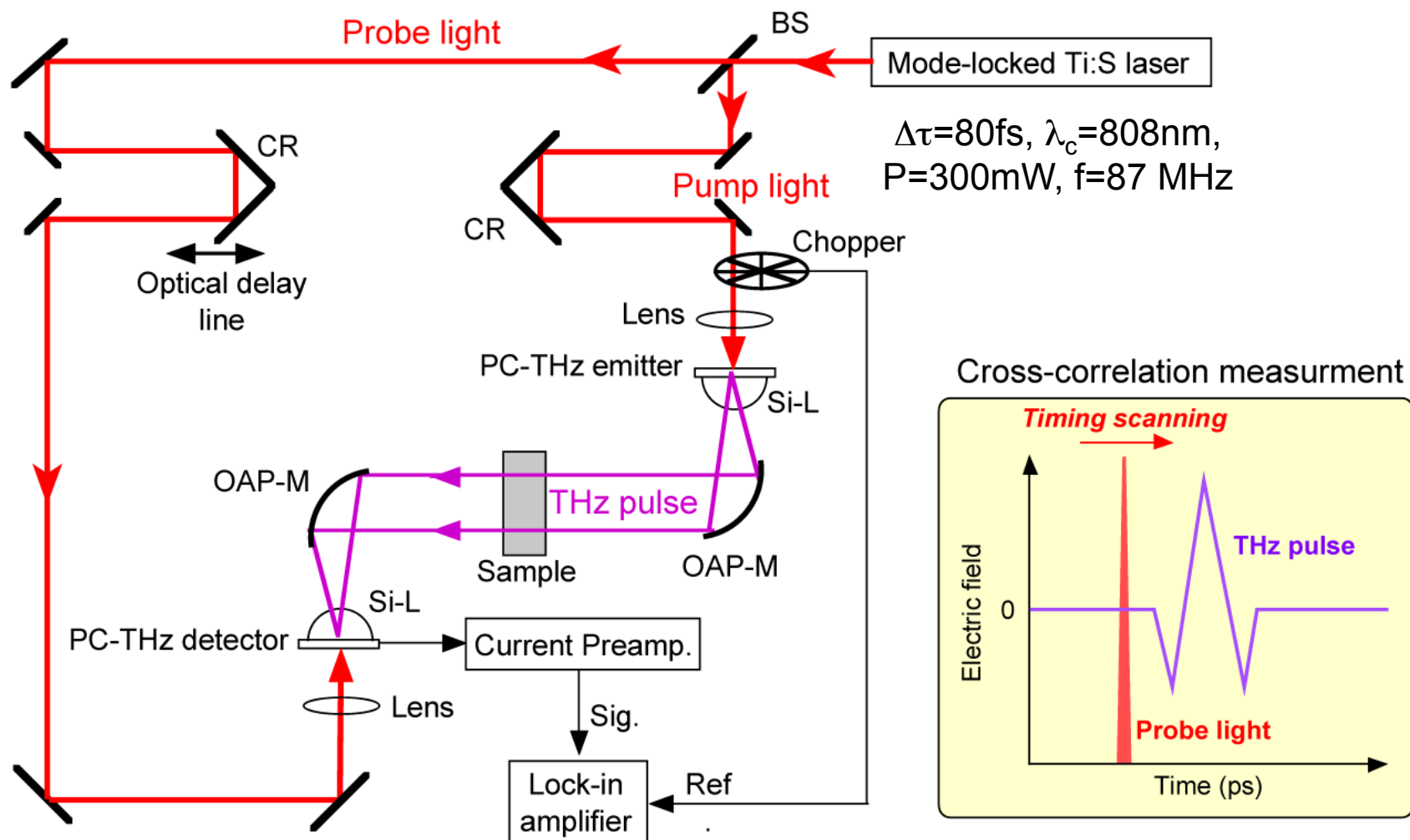

Major modification

Use of bow-tie shape antenna as a THz emitter and detector to achieve sensitivity in the low-frequency THz region less than 0.3 THz

Basic performance

Water content measurement

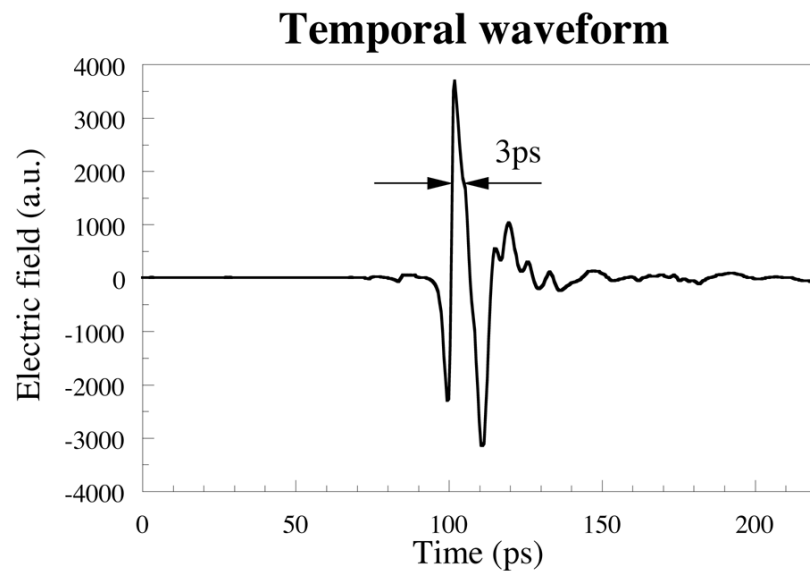

Fourier Transform

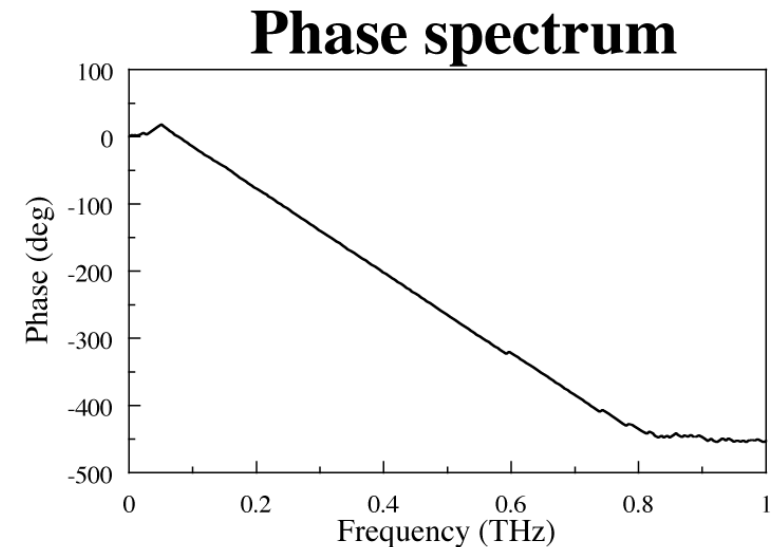
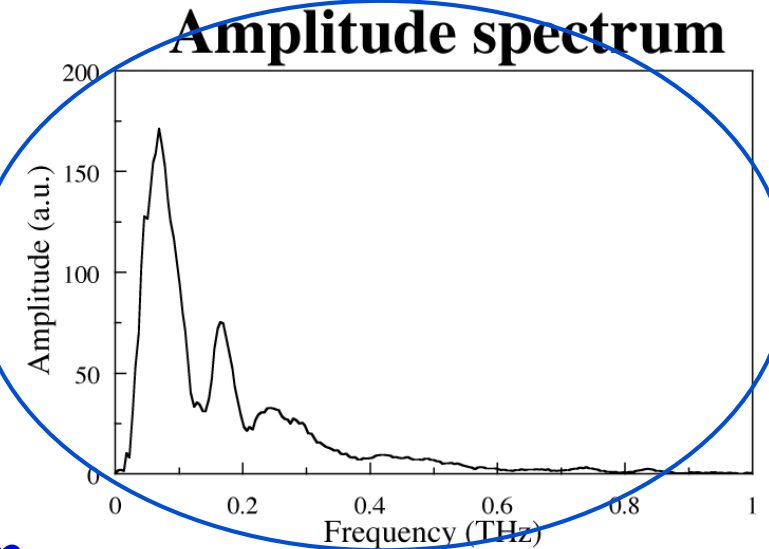

**THz Time-Domain Spectroscopy
(THz-TDS)**

Transmittance spectrum of pure water

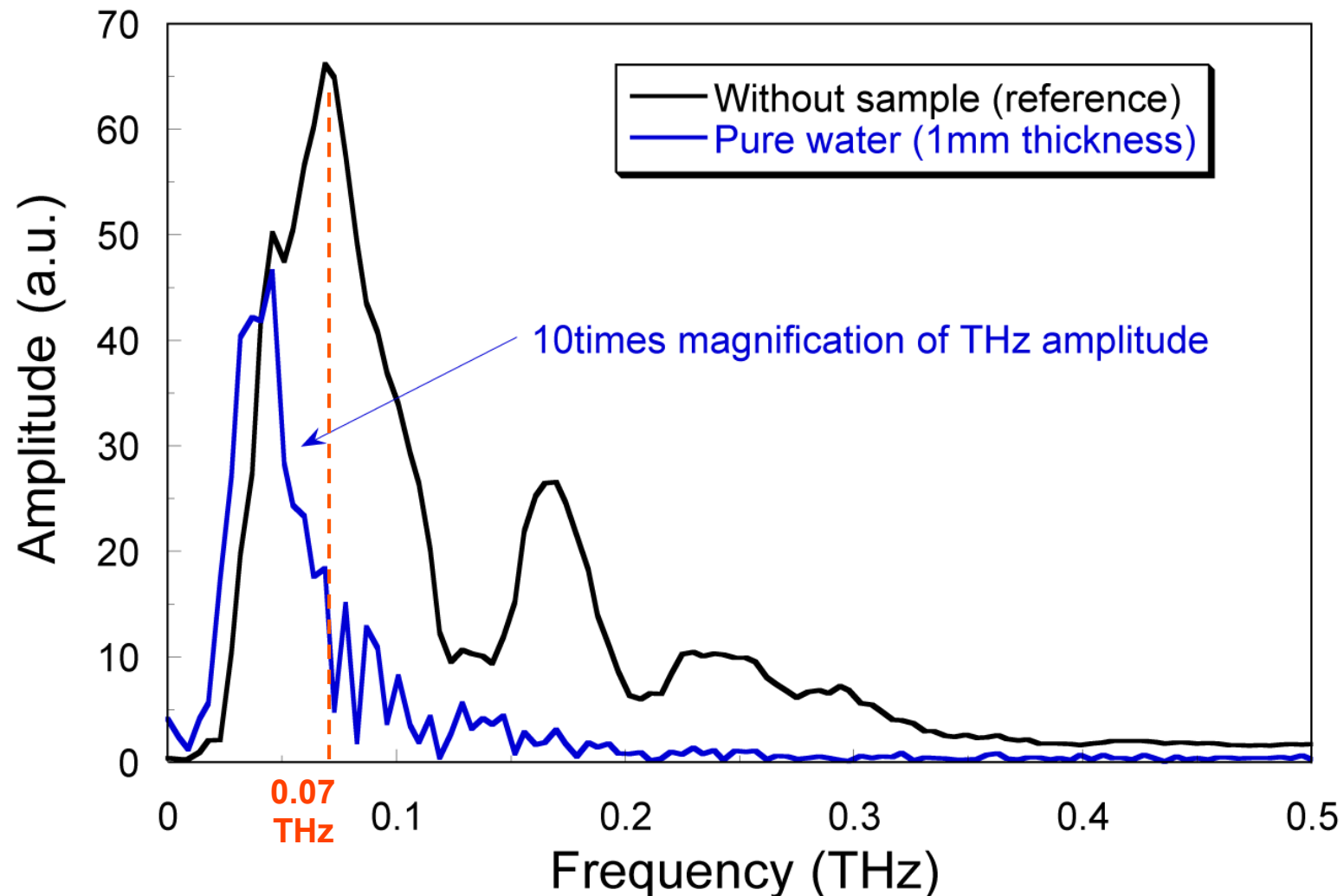

THz wave over 0.1 THz is disappeared by broadband, strong absorption of water.
THz absorption at 0.07 THz is used for quantification of water content.

Relationship between THz absorption and amount of water

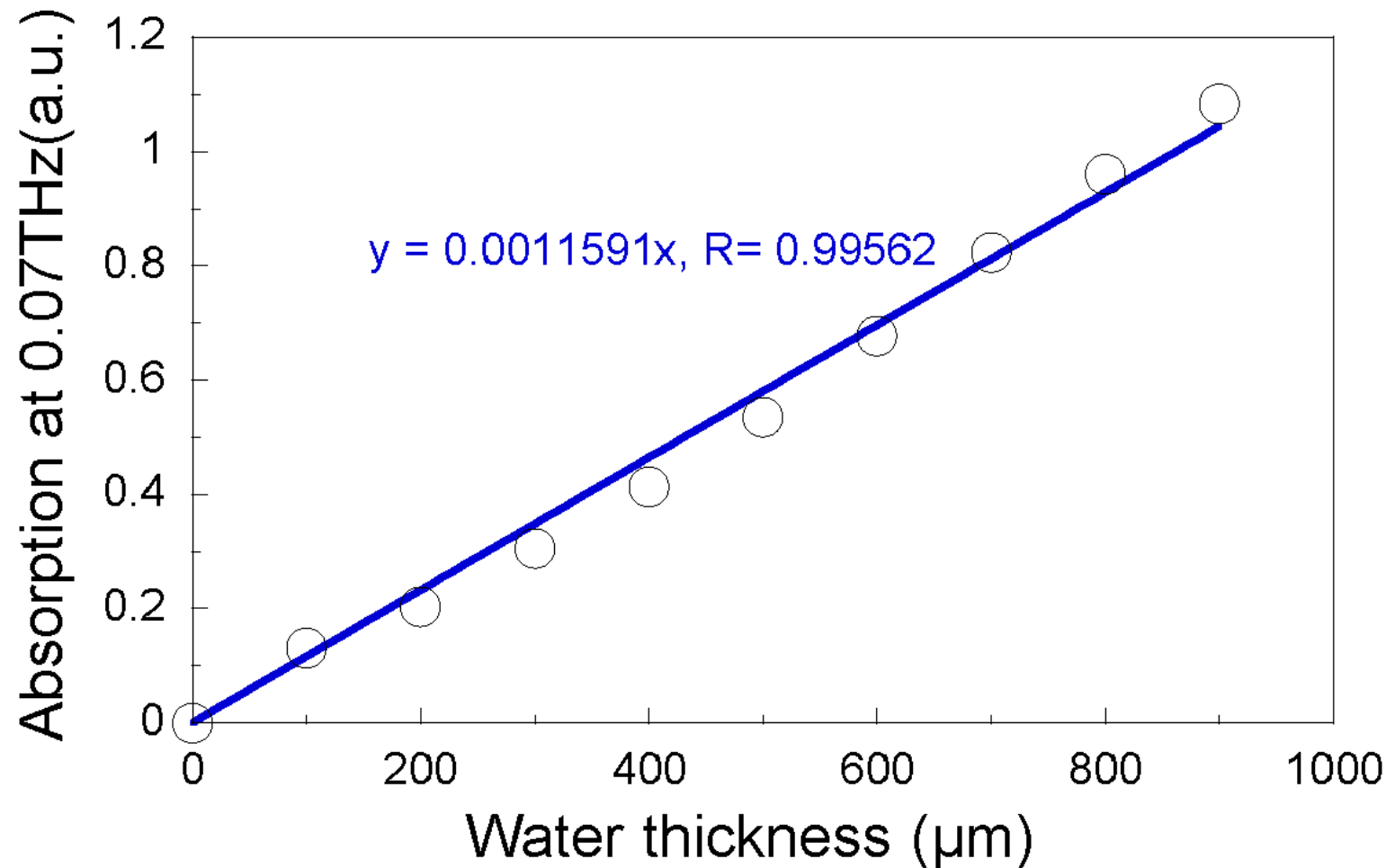

Good correlation between water thickness and THz absorption at 0.07 THz.
→ Amount of water content is calibrated from THz absorption using this relationship.

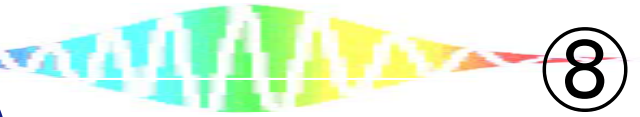

Application (1)

Drying progress of wet tissue paper

To evaluate performance of THz-TDS for water content measurement

Comparison with an weight method using an electronic balance

Drying progress of wet tissue paper

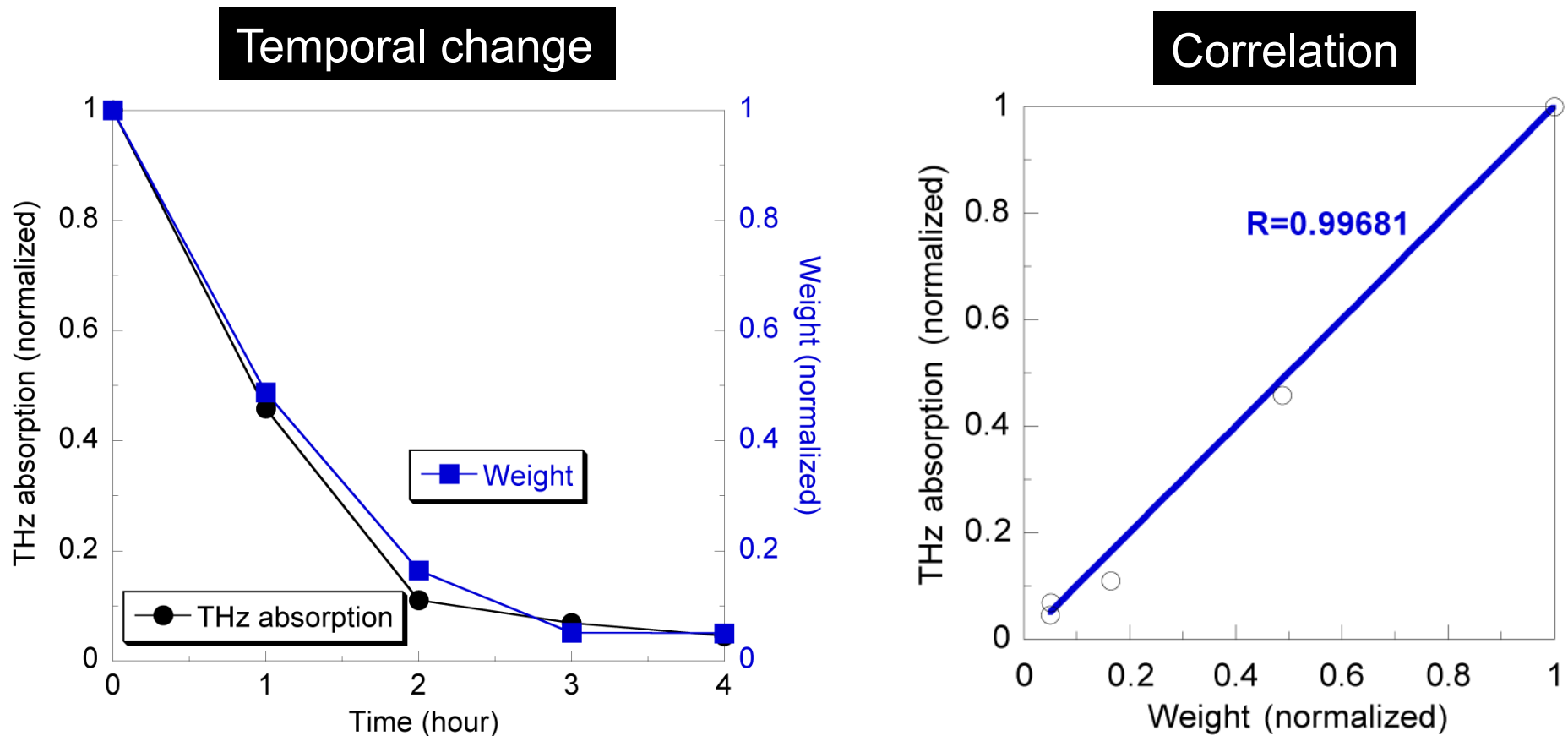

Good correlation between the two methods indicates good performance of water content measurement using THz-TDS.

Application (2)

Water content in adhesive for wood

Evaluation of hardening degree of adhesive

Hardening caused by evaporation of water
@ adhesive for wood

Non-contact monitoring of adhesive
hardening using THz absorption of water

Water content in adhesive for wood (1)

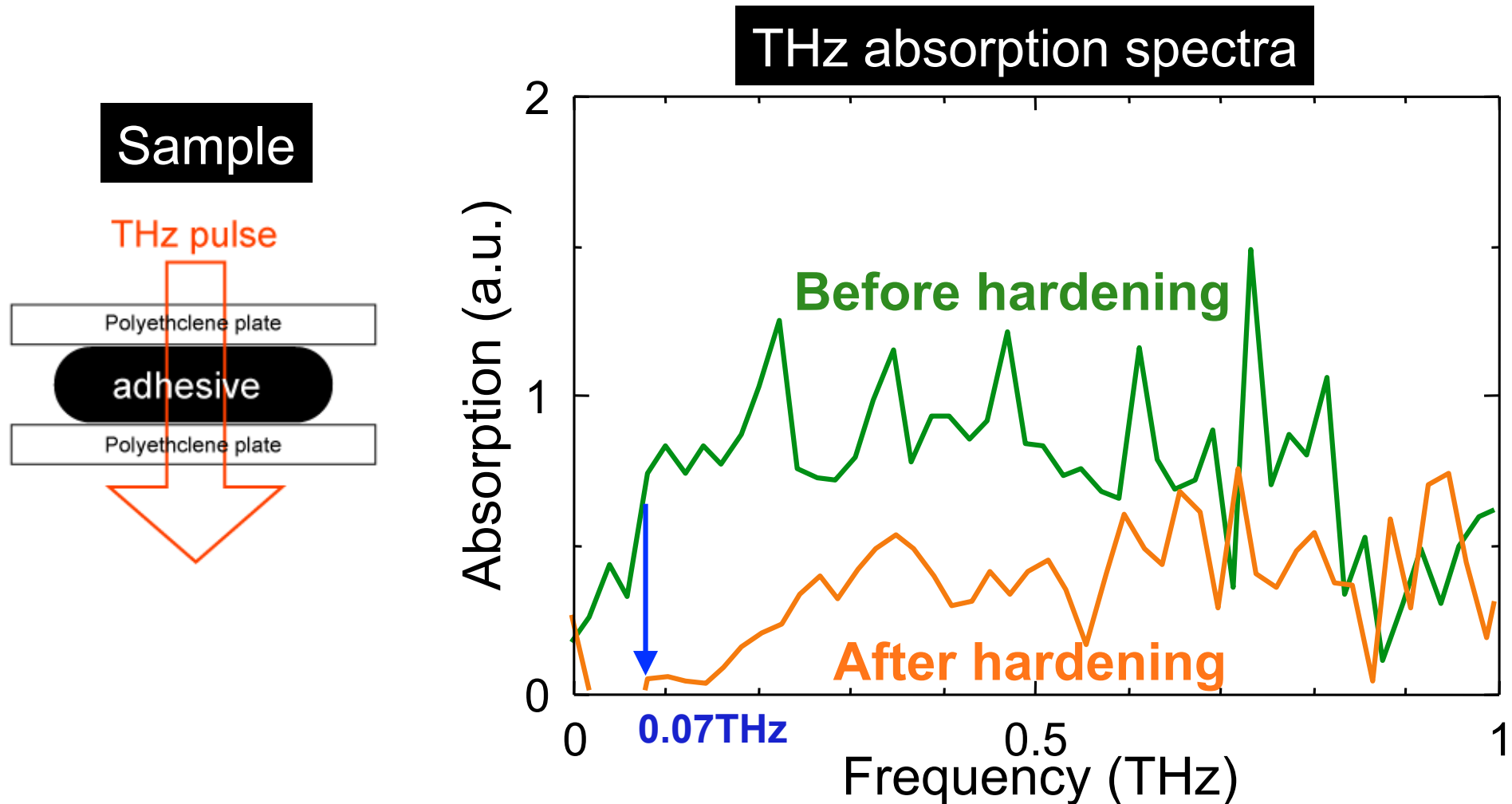

Difference of THz absorption spectra before and after hardening of the adhesive is obvious.

Water content in adhesive for wood (2)

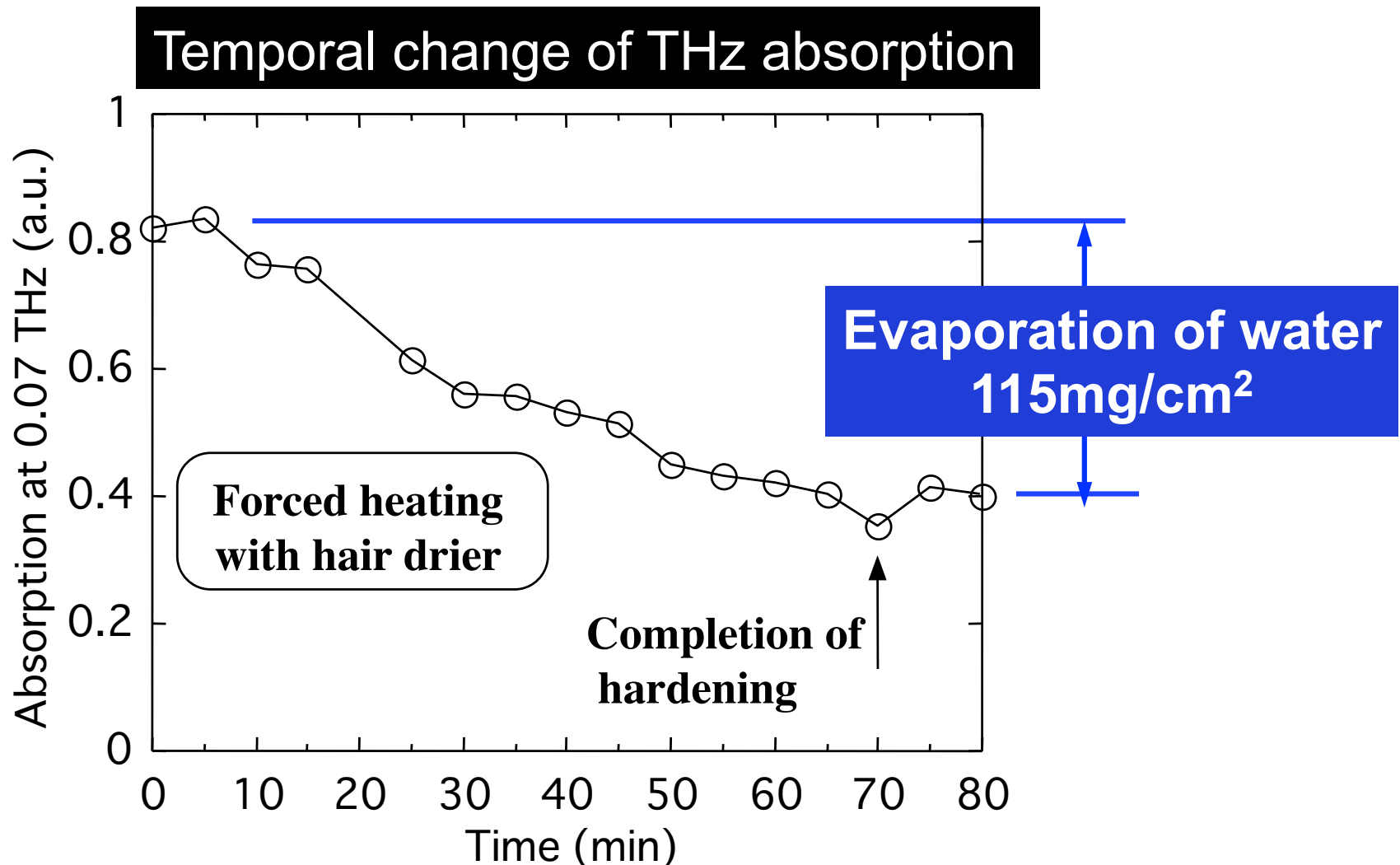

Gradual decrease of THz absorption indicates slow evaporation of water, and hence slow hardening of adhesive.

Temporal change of THz absorption is stopped at 70 min, which implies completion of adhesive hardening

Application (3)

Water content in instant coffee powder

Excessive water content in dried food



Rotting or mold of food !



In-process monitoring of a very small amount of water content is required for strict quality control of dried food!



Direct , remote monitoring of water content
in bottled instant coffee powder

Water content in instant coffee powder (1)

THz transmittance spectra

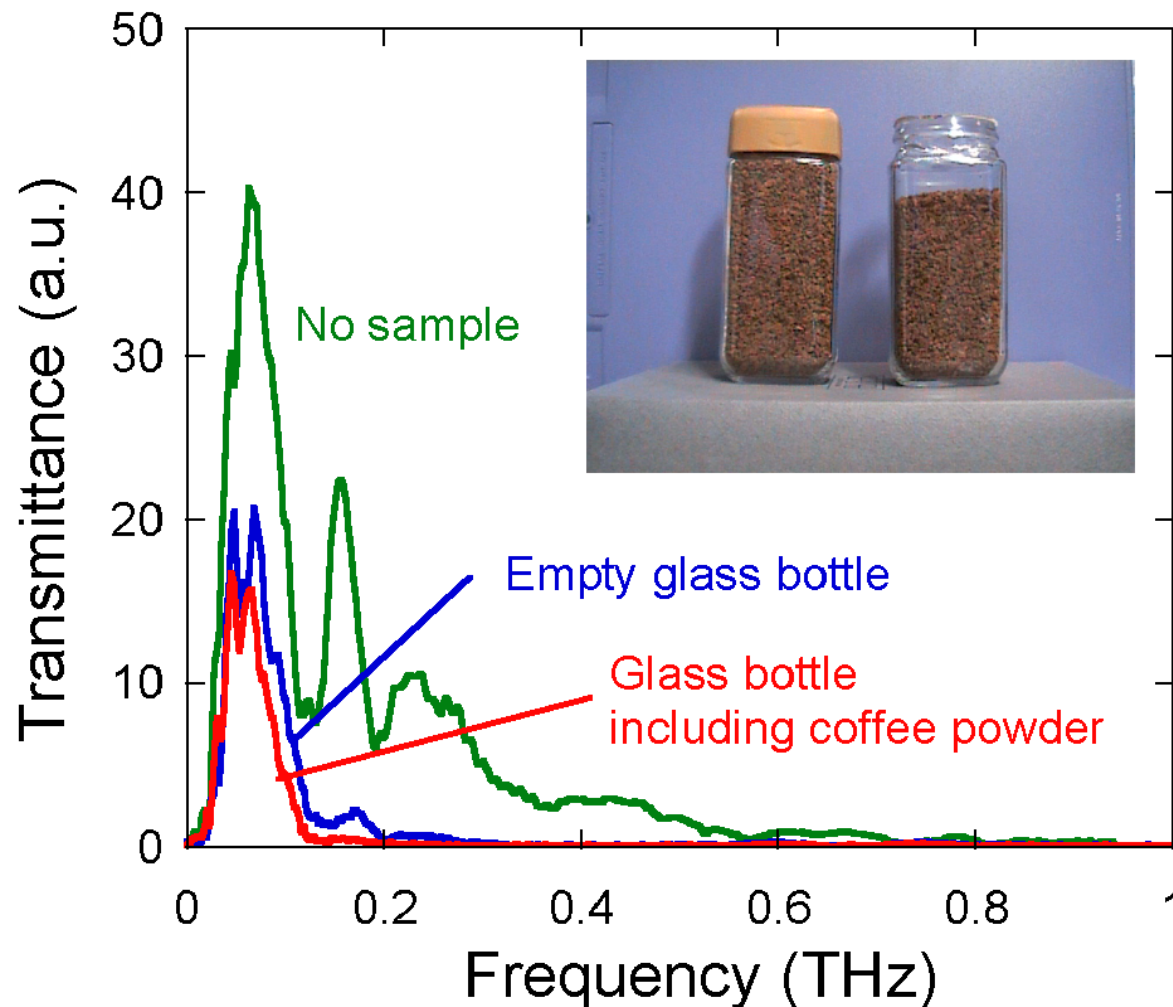

Empty glass bottle strongly absorbs THz wave > 0.1 THz because of water in the glass.

THz wave < 0.1 THz is not significantly absorbed and scattered by coffee powder.

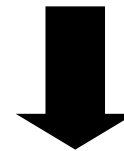

Low-frequency THz-TDS is available for water content measurement.

Water content in instant coffee powder (2)

Water content in the bottled coffee powder increased by forced humidifying

THz transmittance spectra of bottled coffee powder

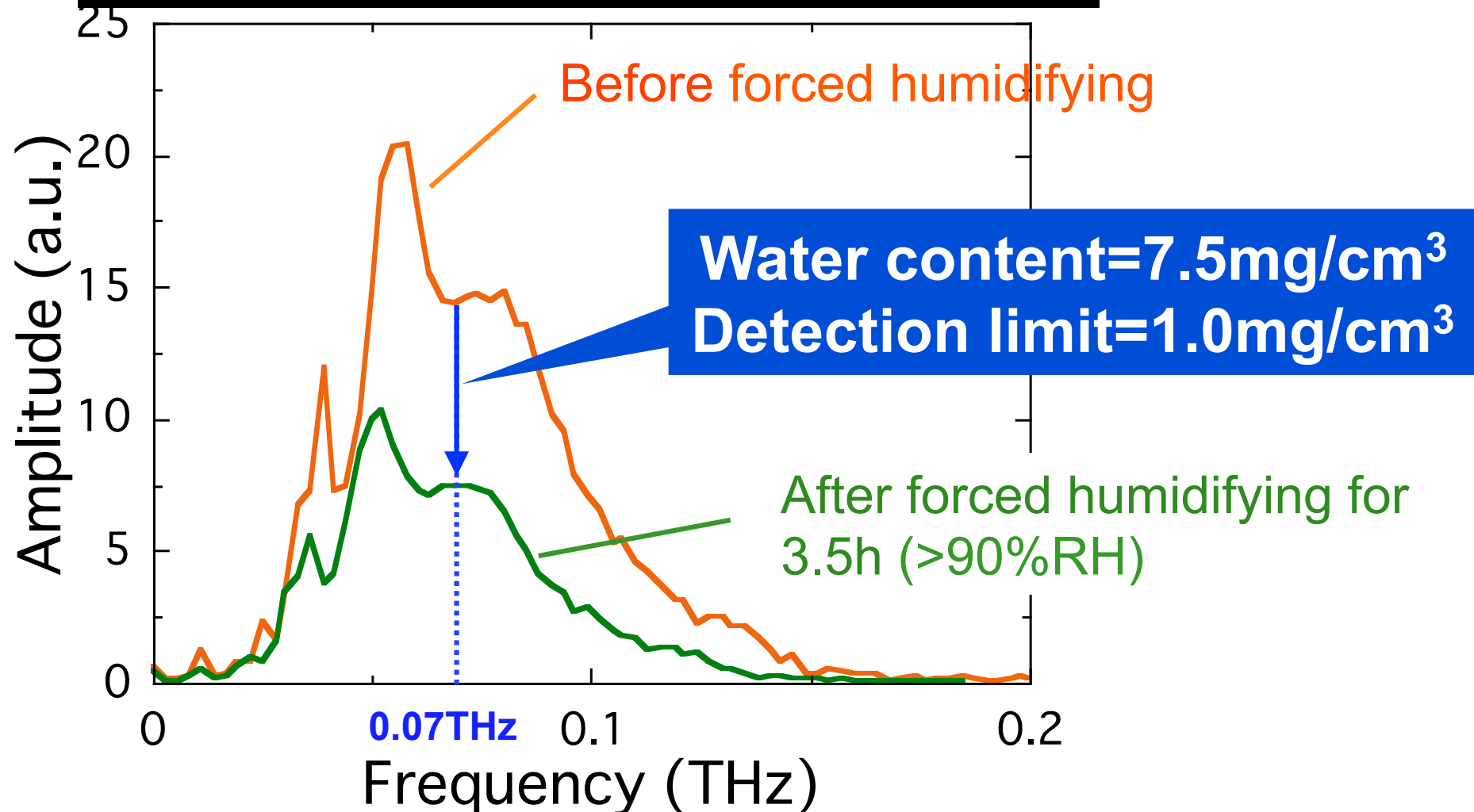

Summary

- (1) Sensitive measurement of water content in dried materials using low-frequency THz-TDS
- (2) Basic performance
 - >High correlation with a electronic-balance weight method
 - >Detection limit = 1mg/cm^3 at coffee powder measurement
- (3) Application
 - >Hardening monitoring of adhesive for wood
 - >Quality control of instant coffee powder in a glass bottle

Acknowledgements

Industrial Technology Research Grant Program 2004 from NEDO of Japan
the Nestle Science Promotion Committee